



**ROLECEV**

# SECURICHARGE

Intelligent EV charging unit



Manufactured  
in the UK

# SECURICHARGE

Intelligent EV charging unit

The SECURICHARGE is the perfect wall-mounted EV chargepoint for workplaces and car parks with its heavy-duty and vandal-resistant features, making it the ideal solution for exposed locations.

This future-proof OCPP compliant unit can offer a simple plug & charge or pay-to-charge solution via the EV driver's smartphone and/or RFID card/fob through any chosen OCPP back-office management system.

Feature-rich, this EV charger supports dynamic load balancing and is equipped with PME fault detection, so there is no requirement for an earth rod, reducing installation costs.

Available in 1way or 2way versions, providing up to 22kW superfast charging.



# Product features

- Plug & charge, mobile app or RFID controlled charging
- Choose from 1x or 2x universal charging socket(s)
- Up to 7.4kW or 22kW charging output(s)
- PME fault detection (no earth rod required)
- Supports dynamic load balancing & static load management
- OCPP 1.6 compliant (can integrate with any back-office)
- Over-the-air firmware / software updates
- Built-in AC overload & fault current protection (RCBO)
- Built-in 6mA DC leakage protection
- Dual tamper and breach security notifications
- Cable lock security feature (can be permanently locked by user)
- Integrated RFID reader
- MID-approved energy metering
- 4G / Wi-Fi / Ethernet connectivity
- IK10 impact resistant design
- Wall mounted
- OZEV grant fundable
- Designed & manufactured in the UK

Powered by  
**MONTA**

Other preferred back-office and mobile app partners:

**Fuuse**

**ChargePlace Scotland**  
electric vehicle charging



**OCPP 1.6 compliant**

Ability to integrate with any OCPP compliant back-office management system and app.

**Easy to operate**

Three quick and easy ways to operate: mobile app, RFID cards and fobs or plug & charge.

**Office for Zero Emission Vehicles**

**Eligible for grant funding**

This range is approved for grant funding via the OZEV Workplace Charging Scheme (WCS).

**4G / Wi-Fi / Ethernet enabled**

Complete with secure 4G, Wi-Fi and Ethernet connectivity, ensuring chargers are always online 24/7.

**Branding & colour options available**

Rolec offers a bespoke chargepoint branding service; from logos & brand colours, to vinyl wraps.

**No earth rod required**

Equipped with built-in TruePEN PME fault detection, saving installation time and costs.

## The details

### UP TO 22KW

Available in both single phase and three phase models, providing up to 22kW superfast charging.

SECURICHARGE is compatible with all EVs & PHEVs, charging at the fastest speed possible, ensuring vehicles are ready to go in no time.

### 2 WAY CHARGING

The SECURICHARGE is available in 1way and 2way versions, allowing two vehicles to charge simultaneously, using just one EV charging unit.

The perfect EV charging solution for fleet, workplace and car park requirements.

### ACCURATE BILLING

Built-in MID-approved energy metering ensures accurate consumption reporting, which is essential for businesses and residential car parks, wishing to bill for their usage. Use our back-office management platform to generate revenue by setting your own tariffs.



### SAFE AND SECURE

Rest assured, Rolec's entire EV chargepoint range is fully UK Smart Charge Point Regulation compliant.

Over-the-air updates allow the chargers to receive the very latest features, ensuring a safe and future-proof product 24/7.

### 3 YEAR WARRANTY

Rolec EV chargepoints are designed, developed and manufactured in the UK and come with a 3 year warranty included as standard, for added peace of mind on your investment.

# Specifications

## Product Overview:

	Connection Type	Charging Output	Input Supply	Unit Colour	Product Code
Single Phase Units	1x Type 2 (IEC 62196) charging socket	Up to 7.4kW (32A)	1x 32A Single Phase 230V AC (±10 %) 50/60Hz	● Black	ROLECO111B
				● Grey	ROLECO111G
	2x Type 2 (IEC 62196) charging sockets	Up to 7.4kW (32A) per socket	1x 63A Single Phase 230V AC (±10 %) 50/60Hz	○ White	ROLECO111W
				● Black	ROLECO121B
			● Grey	ROLECO121G	
			○ White	ROLECO121W	
Three Phase Units	1x Type 2 (IEC 62196) charging socket	Up to 22kW (32A)	1x 32A Three Phase 400V AC (±10 %) 50/60Hz	● Black	ROLECO113B
				● Grey	ROLECO113G
				○ White	ROLECO113W
	2x Type 2 (IEC 62196) charging sockets	Up to 22kW (32A) per socket	1x 63A Three Phase 400V AC (±10 %) 50/60Hz	● Black	ROLECO123B
				● Grey	ROLECO123G
				○ White	ROLECO123W

SecuriCharge 1way unit:

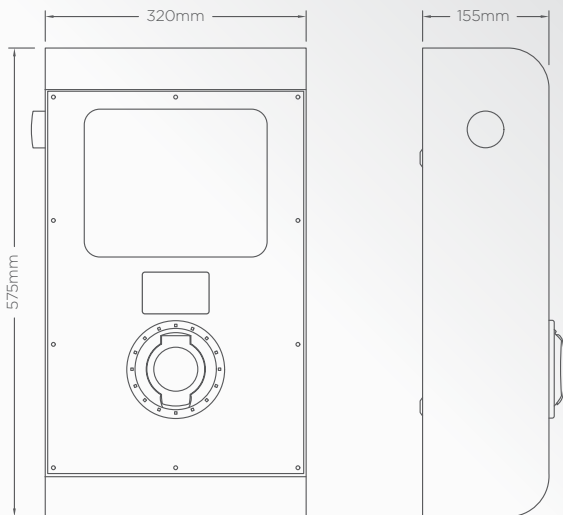

SecuriCharge 2way unit:

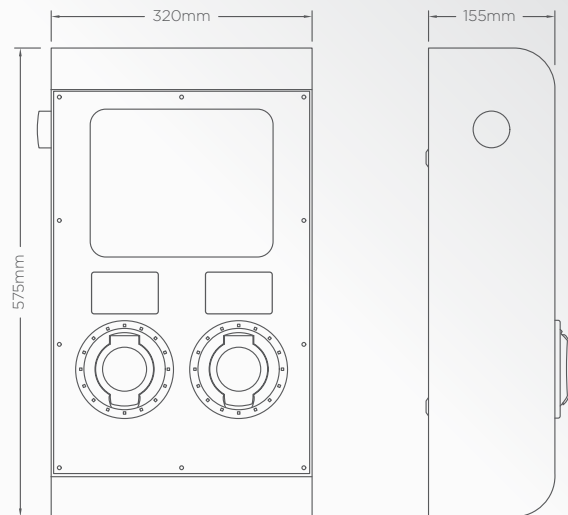

# Specifications

## Technical Data:

<b>User Interface</b>	<ul style="list-style-type: none"> <li>• Mobile app</li> <li>• RFID reader (MIFARE ISO/IEC 14443 A)</li> <li>• Plug &amp; charge</li> <li>• RGB LED status indicator halo(s) – configurable</li> </ul>
<b>Charge Protocol</b>	Mode 3 (IEC 61851-1)
<b>Protection</b>	<ul style="list-style-type: none"> <li>• AC overload &amp; fault current protection – 40A 30mA Type A RCBO (per socket)</li> <li>• DC fault protection – 6mA</li> <li>• Lightning surge, over temperature protection</li> <li>• TruePEN PME fault detection – No earth electrode/rod required</li> <li>• Supports automatic dynamic load balancing (may require additional hardware)</li> <li>• Supports static load management (software configurable)</li> </ul>
<b>Cable Terminals</b>	<ul style="list-style-type: none"> <li>• Single Phase – 3x 50mm 1P + N + E</li> <li>• Three Phase – 5x 50mm 3P + N + E</li> </ul>
<b>Communications</b>	<ul style="list-style-type: none"> <li>• 4G LTE Cat-1 (built-in nano SIM, subscription required) <ul style="list-style-type: none"> <li>• LTE FDD: B1/B3/B5/B7/B8/B20/B28</li> <li>• GSM: B2/B3/B5/B8</li> </ul> </li> <li>• Wi-Fi 802.11 b/g/n 2.4 GHz (2412-2472 MHz / 2422-2462 MHz)</li> <li>• NFC 13.56 MHz</li> <li>• RJ45 Ethernet connection</li> <li>• Bluetooth Low Energy (BLE 4.1) 2402-2480 MHz (for installer configuration purposes)</li> <li>• OCPP 1.6J</li> <li>• Cyber security – Data encryption level TLS 1.2</li> </ul>
<b>Energy Metering</b>	Integrated Class 1 MID compliant metering
<b>Standby Power Consumption</b>	< 7.5W (per socket)
<b>Dimensions</b>	320mm x 575mm x 155mm (W x H x D)
<b>Weight</b>	< 13kg (model dependant)
<b>Environmental</b>	<ul style="list-style-type: none"> <li>• Ingress protection – Enclosure IP54, Socket IP54</li> <li>• Impact protection – IK10</li> <li>• Security – Dual tamper and breach notifications</li> <li>• Operating temperature – -30°C to +50°C</li> <li>• Operating humidity – 5% to 95%</li> </ul>
<b>Materials</b>	<ul style="list-style-type: none"> <li>• Body - Heavy duty 1.5mm Steel applied with 45-55 microns of Zinc primer</li> <li>• Finish - Corrosive resistant, textured Polyester powder coating</li> </ul>
<b>Unit Colour</b>	 Black  Grey  White  Other colours available upon request
<b>Certifications &amp; Compliances</b>	<ul style="list-style-type: none"> <li>• EV Charging Compliance – EN 61851-1:2019, EN 61851-22:2002</li> <li>• Smart Charge Points – (SI 2021/1467)</li> <li>• Wiring Regulations – BS 7671:2018+A2:2022</li> <li>• EMC Compliance – EN 61000-6-3:2007+A1:2011, EN 61000-6-2:2005, 2014/30 /EU, SI 2016/1091</li> <li>• Safety Compliance (LVD) – EN 62368-1:2014, 2014/35/EU, SI 2016/1101</li> <li>• Communications / RED – EN 62311:2008, 2014/53/EU, SI 2017/1206, EN 300 330 V2.1.1 (2017-02), EN 301 908-1 V15.1.1 (2021-09), EN 301 908-13 V13.2.1 (2022-02), EN 301 511 V12.5.1 (2017-03), EN 300 328 V2.2.2 (2019-07), EN 300 440 V2.2.1 (2018-07)</li> <li>• Environmental Protection – BS EN 60529:1992+A2:2013</li> <li>• Impact Rating – BS EN 62262:2002+A1:2021</li> <li>• Metering – 2014/32/EU, SI 2016/1153</li> <li>• RoHS – 2011/65/EU, SI 2012/3032</li> <li>• REACH – 1907/2006, REACH etc. (Amendment) Regulations 2021</li> <li>• Certification Markings – CE &amp; UKCA</li> </ul>
<b>Warranty</b>	3 years

# Options & accessories

Product Code	Item Description
RFID0010	RFID card
RFID0020	RFID fob
EVCB0020	Root mount protection barrier - 48mm
EVCB0040	Surface mount protection barrier - 48mm
EVPS0010	EV parking sign - A4 landscape (Other sizes are available)
EVPP0100	5m 32A Type 2 to Type 2 charging cable
EVPP0107	10m 32A Type 2 to Type 2 charging cable
EVPP0105	5m 32A Three phase Type 2 to Type 2 charging cable
EVPP0108	10m 32A Three phase Type 2 to Type 2 charging cable (Other cables are available, including Type 1 options)
EVRS0030	Remote wall mount for Type 2 charge plug holster
ACSR0125	100A up to 35mm <sup>2</sup> screened CT clamp with 10m cable



RFID0010  
RFID0020



EVRS0030



EVPS0010



ACSR0125



EVCB0040





### Branding & colour options available

Rolec offer a bespoke chargepoint branding service; from logos & brand colours, to vinyl wraps. This can be arranged at time of order. Contact Rolec for details.



Brand names, logos and trademarks used herein remain the property of their respective owners. This listing of any firm or their logos is not intended to imply any endorsement or direct affiliation with Rolec Services Ltd. and is purely to demonstrate branding opportunities.

# Chargepoint management

















Monta's chargepoint management platform provides businesses and organisations with the ability to deploy and self-manage their very own electric vehicle charging network. Ideal for workplace, fleet, commercial and residential locations.

Other preferred back-office partners:

+ many more

-  Full & automated control of your chargepoints
-  Unlock additional revenue streams
-  Set chargepoints for public and/or private use
-  Set different pricing for individual chargepoints & groups
-  Dynamic pricing allows operators to set pricing in line with their hour-by-hour energy cost
-  Fully scalable solution; add or remove chargepoints & users
-  Complete fleet management solutions with analytical feedback & reporting
-  Reduce charging costs and CO<sub>2</sub> with Smart Charge feature
-  Vehicle integration provides visibility of battery size, SOC, percentage & location etc.
-  Automatically reimburse employees' home charging
-  Smart queuing system that sends notifications to drivers when they become available
-  Over-the-air updates and self-healing algorithms ensure charger stability & availability
-  Static, Dynamic or True Dynamic load balancing options
-  EV Roaming feature, allowing chargepoints to be available on other apps



**Charge point settings**  
Set charge point to public

Private  Public

**Reserve charge point**  
Book charge points at a time that suits you the best!

[Reserve](#)

**Easy payment for your employees**

**Charge revenue** Feb 23 +3.48%

▶ For more information about Monta's chargepoint management solutions and pricing, see the Powered by Monta Overview Sheet



# Chargepoint operation



Charge your EV on your terms. With Monta you have full control over your charging experience, at home or on the road.

- Easily locate and navigate using the chargepoint map
- Remotely control your home EV charging
- Choose your ready time and choose to prioritise lower costs, lower CO<sub>2</sub> or only using renewable energy
- Schedule charges so your car is ready when you are
- Integrate with most EV manufacturer apps and cars
- Real-time information on your car and battery levels to maximize your charging experience
- Share and give charging access to friends, family and guests
- Set your home charger for public use with custom pricing
- Access to over 300,000 public chargepoints across Europe
- Easily initiate charging and complete payments via credit card, Apple Pay, Google Pay or Monta Wallet
- Online chat or support line for help when you need it most

The Monta app is 100% free with no subscription cost when charging at home

Other preferred mobile app partners:

- Fuuse
- ChargePlace Scotland electric vehicle charging
- ev.energy



DOWNLOAD THE APP



## RFID activation

Great for quick activation, RFID cards or key fobs are easily accessible and add for a much simpler charging experience, which can also be used alongside the mobile app.



▶ For more details about the Monta solution for EV drivers and the Monta app, please visit [www.monta.com/uk/home-charging](http://www.monta.com/uk/home-charging)



THIS DOCUMENT CONTAINS INFORMATION THAT IS SUBJECT TO CHANGE WITHOUT NOTICE.

The latest version of this publication can be downloaded at <https://www.rolecserv.com/downloads-ev-charging>

Illustrations of the product and user interface are for marketing purposes only.

Brand names, logos and trademarks used herein remain the property of their respective owners. This listing of any firm or their logos is not intended to imply any endorsement or direct affiliation with Rolec Services Ltd. and is purely to demonstrate branding opportunities.

© 2023 by Rolec Services Ltd. All rights reserved.

EVSD-V01-R7 SecuriCharge Data Sheet



Manufactured  
in the UK

**ROLEC**EV

t: 01205 724754

e: [enquiries@rolecserv.co.uk](mailto:enquiries@rolecserv.co.uk)

[www.rolecserv.com](http://www.rolecserv.com)

